

Superior V-Guided
Belt Tracking

High Speeds -
Up to 600 fpm

Fast & Simple to Use
Online Configurator

Industry-Best
Product Transfers

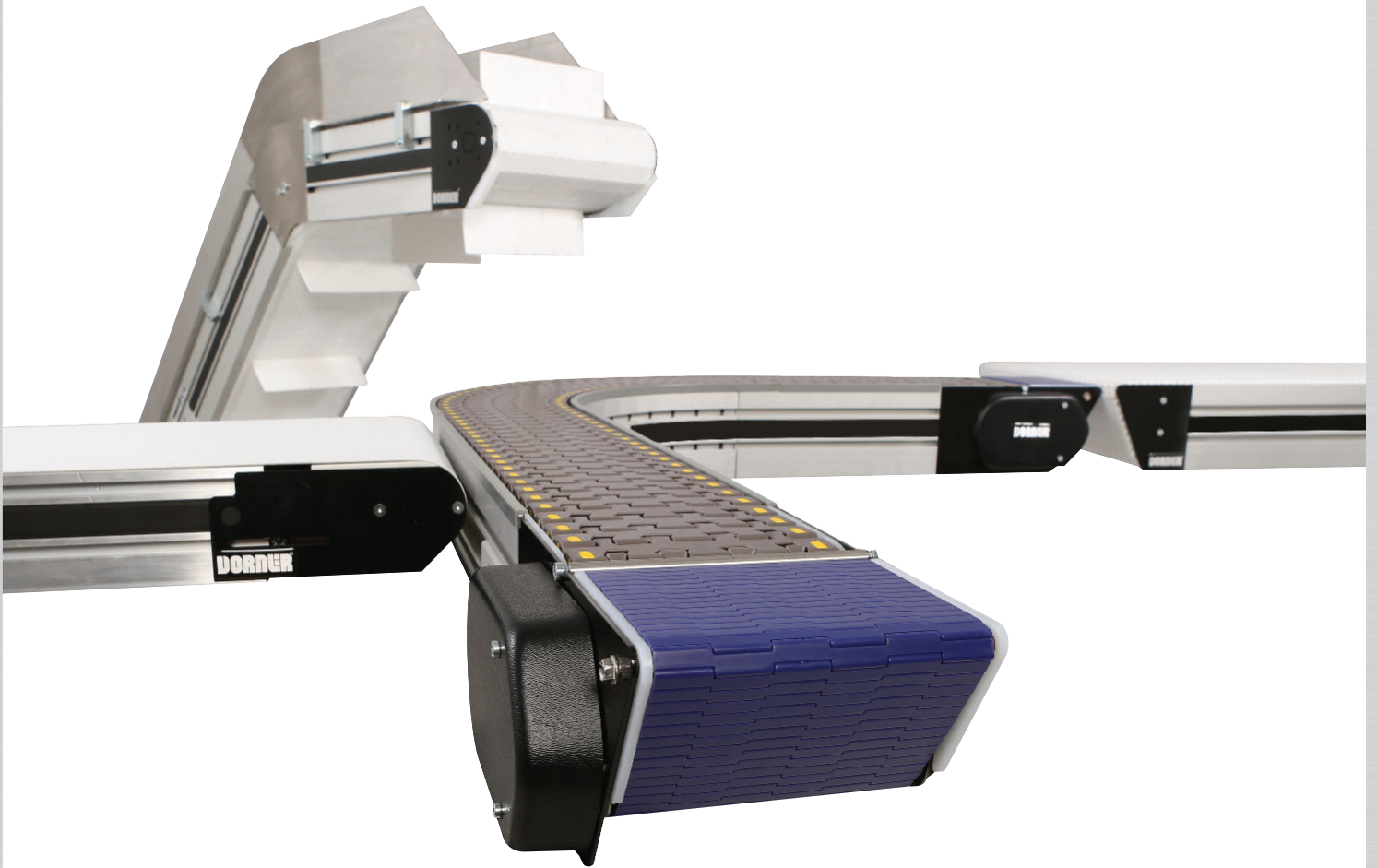

3200 SERIES CONVEYORS

Heavy Duty, Low Maintenance
Fabric & Modular Belt Conveyors

DORNER[®] 

3200 SERIES

3200 Series Conveyors are best for:

- Part Handling
- Transfers
- Accumulation
- Precision Part Movement
- Part Incline/Decline Routing (Z Frames)
- Positioning
- Automated and Manual Assembly
- High Speeds
- Long Runs
- Mainline Packaging

Sizes & Measurements

- 95 - 1524 mm (3.75 - 60 in) widths
- 0.9 - 30 m (3 - 99 ft) lengths

Loads & Speeds

- Up to 454 kg (1000 lbs)
- Up to 183 mpm (600 fpm)



Conveyor Configurations



Straight



Z-Frame

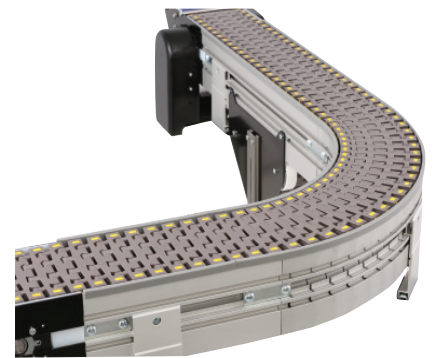

Curve
(Modular Belt Only)



Nose-Over

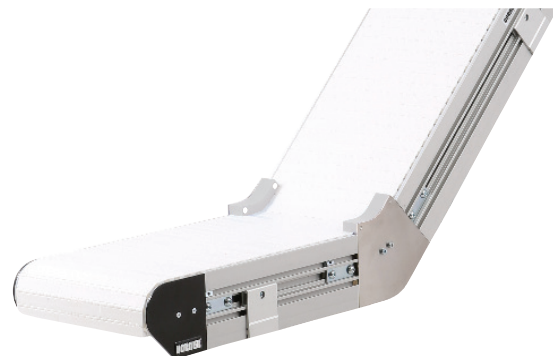

Horizontal to Incline

Fabric Belt Types

- Flat Belt
- Flat Belt Cleated
- Sidewall Cleated
- Rib Top Belt



Flat Belt



Flat Belt Cleated



Sidewall Cleated

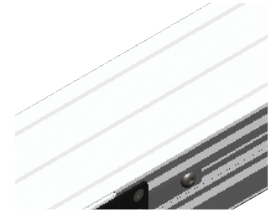

Rib Top Belt

Splicing



Finger Splice

All belts are available with a standard Thermoformed finger splice. This splice makes the belt continuous and is virtually undetectable.



Plastic Clipper

An optional plastic clipper splice is available for quick removal of belts or when conveyors are installed in tight spaces.



Metal Clipper

An optional metal clipper splice is also available for quick removal of belts or when conveyors are installed in tight spaces.

In-House Fabricaton Capability

- Large Quantity of Stocked Materials
- Continuous V-Guiding
- Water Cooled Belt Splicing
- RF Cleat Welding
- Hole Punching



Precision Move Belt Types

- Precision Move
- Precision Move Cleated
- Precision Move with Fixtures
 - Provides an accurate mounting bar for pallet attachment



Precision Move

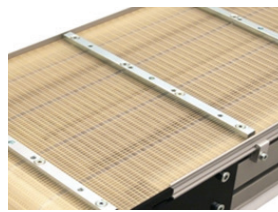

Precision Move with Fixtures

Modular Belt Types

- Flat Top
- Flush Grid
- Friction Inserts
- Cleated
- Roller Top



Flat Top



Cleated



Curved Modular Belt Types

- Basic Single Curve
- Low Backpressure Roller Top Curve
- Friction Insert Curve
- High Strength Tab Curve
- High Strength Bearing Curve



High Strength Curve

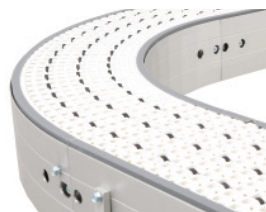

Roller Top

Product Transfers

Industry-Best Transfers

- Nosebar Drive and Idler Tails (20 mm Dia.)
- Outfeed/Infeed Powered Transfer
- Infeed/Outfeed Roller Transfer



Modular Belt
Nosebar Tails



Fabric Belt
Nosebar Tails

Frame Styles

Standard T-Slot Frame

Mounting accessories is simple without drilling or special tools.

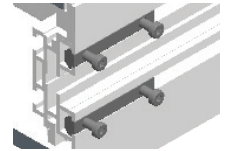

SmartSlot® Frame

SmartSlot technology in the frame functions like a T-slot without the collecting of debris.

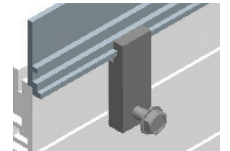

Optional Mid Slot Cover

Provides cover for wiring and pneumatic lines.



Drive Types

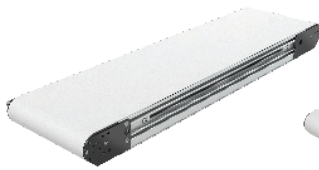

End Drive



Center Drive



iDrive®



Weighted Take-Up Module

Eliminates catenary sag and improves safety. Standard on modular belt conveyors with curves or nosebars.

Flat Belt Conveyor Drive Options

Guiding

Multiple Guiding Options

- Low Side
- Aluminum High Side
- Wiper
- Fully Adjustable
- Adjustable Outboard
- Stainless Steel Side
- Flared Guiding

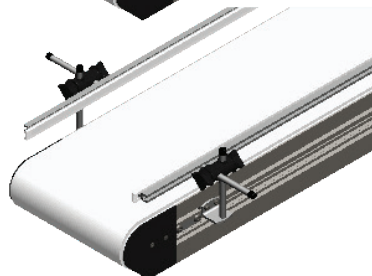
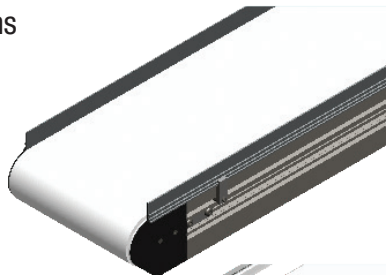

Controls

- VFD Controllers
- Brushless DC Controllers
- Remote Start VFD Controls
- Programmable Servo Controls



Stands

Multiple Stand Options

- Fixed Height Support Stands
- Adjustable Height Support Stands
- Single Post & Pillar Support Stands



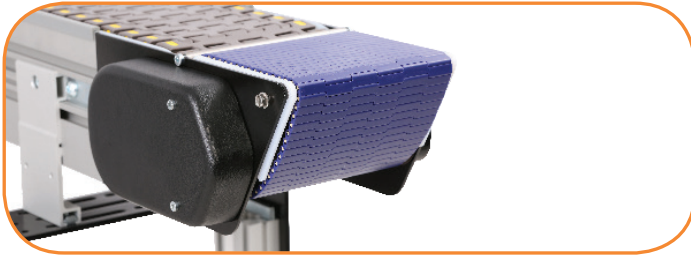

Powered Transfers

- Provides smooth worry free transfer of parts as small as 76 mm (3 in) in diameter, even on curves



High Performance Bearing Style Curve Design

- Provides the capability of complex conveyor shapes with up to 4 corner modules

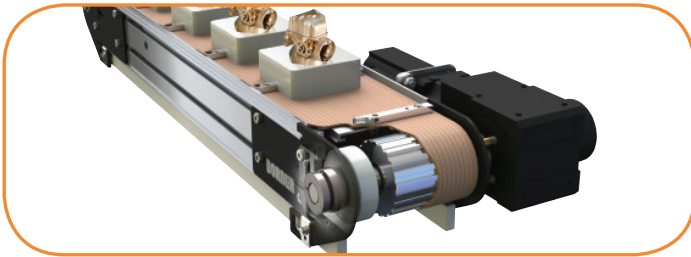

Precision Move Conveyors

- Accurate part location of up to .25 mm (.010 in) in belt widths to 457 mm (18 in) wide



iDRIVE

- The industry's most compact internal drive for 24/7 operation in conveyors as narrow as 152 mm (6 in) wide



Flush Side Frames

- All bearings and components located inside conveyor frame for flat sided tails to fit in tight spaces



V-Guided Belt Tracking

- Superior V-Guided belting eliminates the need for tracking adjustments

The Benefits of a Dorner 3200 Series Conveyor

Low Maintenance

- Dorner's Industry Best V-Guiding provides positive belt tracking, even under demanding side load applications
- Modular belts and spliced standard belts allow for quick belt changing, reducing downtime
- Precise rack and pinion belt tensioning
- Sealed for life bearings

Time Saving

- Dorner's online configurator engineers simple or complex conveyors to meet your needs in minutes
- The industry leading tool delivers a complete 3D CAD assembly model for instant validation of fit
- Dorner provides the industry's fastest deliveries

Industrial & Automation Conveyors

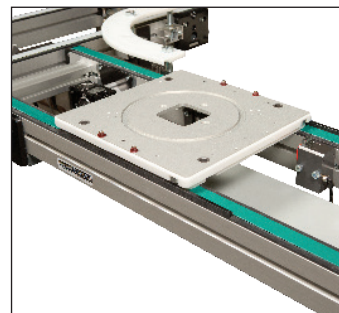
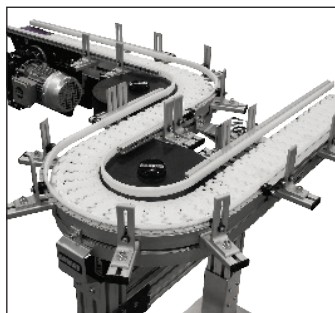
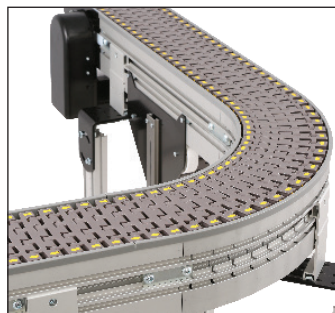
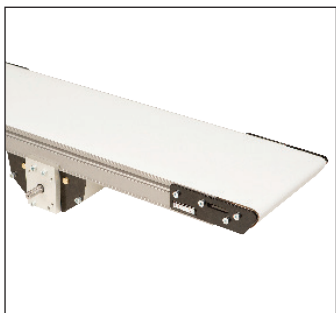

Sanitary Conveyors

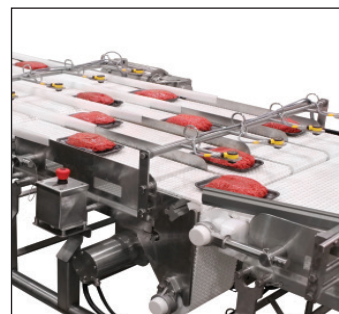
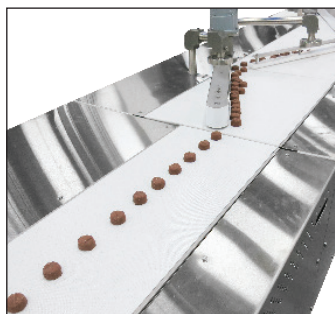
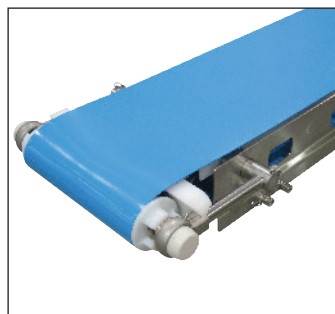

Engineered Solutions



Parts

Service

Online Configurator

Warranty

Transforming Conveyor Automation

Dorner – North & South America

Dorner – U.S.A. Headquarters
975 Cottonwood Ave
Hartland, WI 53029, USA
(800) 397-8664
(262) 367-7600
info@dorner.com

Dorner – Canada
100-5515 North Service Road
Burlington, Ontario L7L 6G6
Canada
(289) 208-7306
info@dorner.com

Dorner – Latin America
Carretera a Nogales #5297,
Nave 11. Parque Industrial Nogales
Zapopan, Jalisco C.P. 45222
Mexico
+52.33.30037400
info.latinamerica@dorner.com



Dorner – Europe

Dorner – Germany
Karl-Heinz-Beckurts-Straße 7
52428 Jülich,
Germany
+49 (0) 2461/93767-0
info.europe@dorner.com

Dorner – France
8-10 Rue de Nieuport
78140 Vélizy-Villacoublay,
France
+33 (0)1 84 73 24 27
info.france@dorner.com

Dorner – Asia

128 Jalan Permatang Damar Laut, Bayan Lepas 11960
Penang, Malaysia
+604-626-2948 | info.asia@dorner.com

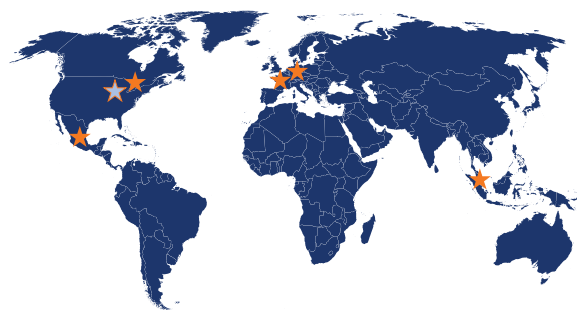

www.dornerconveyors.com